



HER201G THRU HER208G

HIGH EFFICIENCY GLASS PASSIVATED RECTIFIER

Reverse Voltage - 50 to 1000 Volts Forward Current - 2.0 Ampere

DO-15

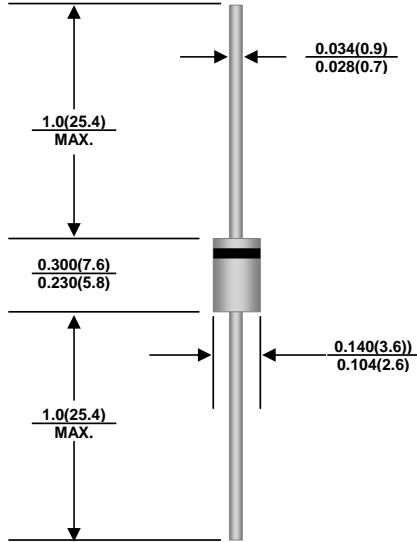

Dimensions in inches and (millimeters)

FEATURES

- ◆ Low power loss, high efficiency
- ◆ Low leakage
- ◆ Low forward voltage drop
- ◆ High current capability
- ◆ High speed switching
- ◆ High current surge
- ◆ High reliability
- ◆ Pb free product : 99% Sn above can meet RoHS environment substance directive request

MECHANICAL DATA

Case: JEDEC DO-15, Molded plastic

Terminals: Solderable per MIL-STD-750 Method 2026

Epoxy: UL94V-0 rate flame retardant

Approx. Weight: 0.014 ounce, 0.395 gram

Mounting Position: Any

MAXIMUM RATINGS AND ELECTRICAL CHARACTERISTICS

Ratings at 25°C ambient temperature unless otherwise specified.

Single phase half-wave 60Hz, resistive or inductive load, for capacitive load current derate by 20%.

PARAMETER	SYMBOLS	HER 201G	HER 202G	HER 203G	HER 205G	HER 206G	HER 207G	HER 208G	UNITS
Maximum repetitive peak reverse voltage	V_{RRM}	50	100	200	400	600	800	1000	Volts
Maximum RMS voltage	V_{RMS}	35	70	140	280	420	560	700	Volts
Maximum DC blocking voltage	V_{DC}	50	100	200	400	600	800	1000	Volts
Average Rectified current at $T_A = 50^\circ\text{C}$	$I_{(AV)}$	2.0							Amp
Non-repetitive Peak Forward Surge Current 8.3ms single half sine-wave superimposed on rated load (JEDEC Method)	I_{FSM}	60							Amps
Maximum Forward Voltage at $I_F = 2.0\text{A}$	V_F	1.0		1.3	1.5	1.7		Volts	
Maximum DC reverse current at rated DC blocking voltage at $T_A = 25^\circ\text{C}$	I_R	1.0							μA
Maximum reverse recovery time (NOTE 1)	t_{rr}	50				75			nS
Typical Junction Capacitance (NOTE 2)	C_J	30				20			pF
Operating Junction & Storage Temperature Range	T_J, T_{STG}	-65 to +150							$^\circ\text{C}$

Note: 1. Reverse recovery condition $I_F = 0.5\text{A}, I_R = 1.0\text{A}, I_{rr} = 0.25\text{A}$

2. Measured at 1MHz and applied reverse voltage of 4.0V D.C.



HER201G THRU HER208G

RATINGS AND CHARACTERISTIC CURVES

FIG. 1 - TEST CIRCUIT DIAGRAM AND REVERSE RECOVERY TIME CHARACTERISTIC

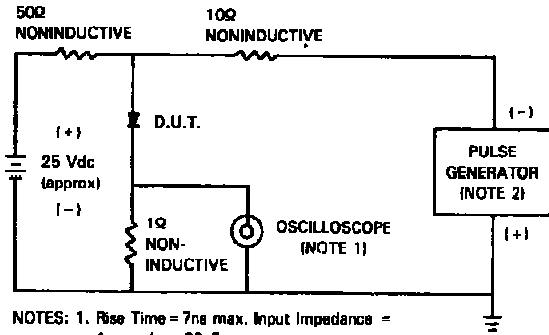

NOTES: 1. Rise Time = 7ns max. Input Impedance = 1 megohm. 22pF.
2. Rise Time = 10ns max. Source Impedance = 50 ohms.

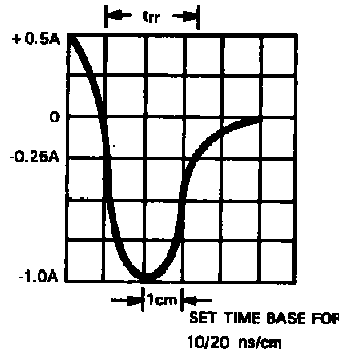

FIG. 2 - TYPICAL FORWARD CURRENT DERATING CURVE

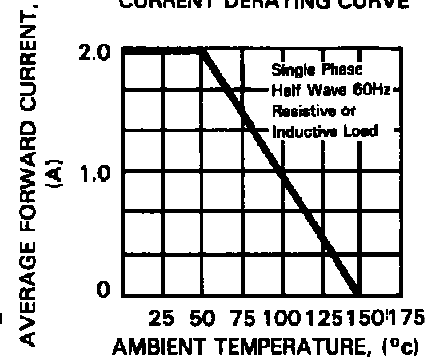

FIG. 4 - TYPICAL INSTANTANEOUS FORWARD CHARACTERISTICS

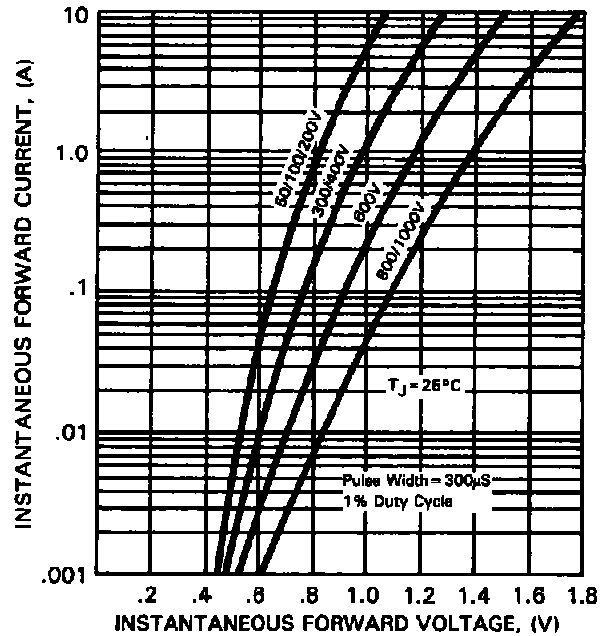

FIG. 3 - TYPICAL REVERSE CHARACTERISTICS

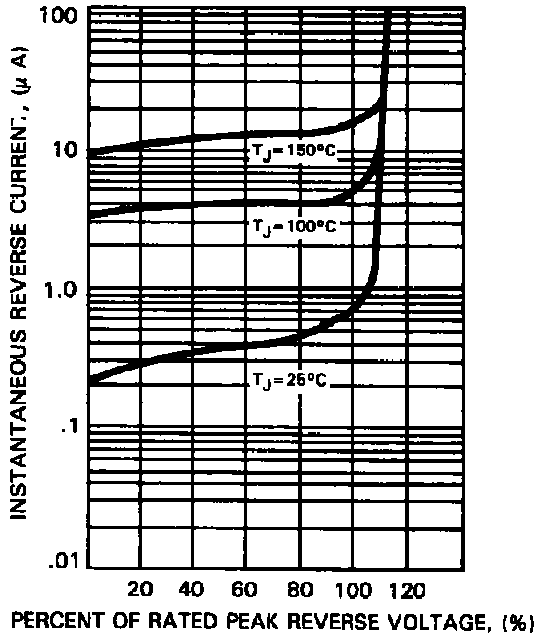

FIG. 6 - TYPICAL JUNCTION CAPACITANCE

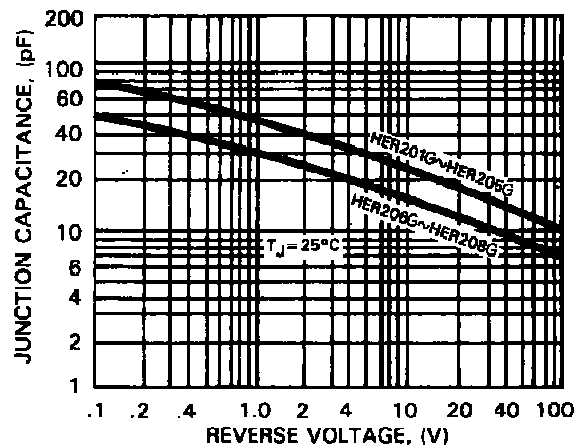

FIG. 5 - MAXIMUM NON-REPETITIVE FORWARD SURGE CURRENT

